

NANO VANITY

NAN-48V (48")

CAUTION

TURN OFF THE MAIN POWER AT THE CIRCUIT BREAKER BEFORE INSTALLING THE FIXTURE IN ORDER TO PREVENT POSSIBLE SHOCK

IF YOU ARE UNFAMILIAR WITH PROPER ELECTRICAL WIRING CONNECTIONS OBTAIN THE SERVICES OF A QUALIFIED ELECTRICIAN

GENERAL

- Read all instructions carefully for safe operation and installation.
- All electrical connections must be in accordance with local and national electrical code (N.E.C) standards.
- Remove the fixture and the mounting package from the box and make sure that no parts are missing by referencing the illustrations on the installation instruction. Please contact Blackjack Lighting if any parts are missing or damaged.
- This product is suitable for damp locations.

INSTALLATION**PREPARATION**

1. Remove the fixture from its box.
2. Remove the fixture pan/ acrylic lens assembly(11/14) from the back panel(10) by loosening the two set screws(12).

MOUNTING

3. Pull the supply wires(2&4) and the house ground wire(6) out of the outlet box(1). Thread them through the large center hole in the back panel(10).
4. Place the back panel(10) over the outlet box(1). Insert the mounting screws(9) through the slots in the back panel(10), then tightly secure them into the outlet box(1).

ELECTRICAL CONNECTIONS

5. Using the wire connectors(8), connect the white supply wire(2) to the white fixture wire(3); connect the black supply wire(4) to the black fixture wire(5); and connect the house ground wire(6) to the fixture ground wire(7).

FINAL ASSEMBLY

6. Secure the fixture pan/ acrylic lens assembly(11/14) to the back panel(10) by attaching the two set screws(12).

DIMMING

- Fixture Dimming Type: TRIAC dimmable
- For recommended dimmers see <https://www.blackjacklighting.com/dimming-information>

HARDWARE



Wire Connectors (#8)
[3 Included]



Mounting Screws (#9)
[2 Included]



Set Screws (#12)
[2 Included]



Allen Wrench (#13)
[1 Included]

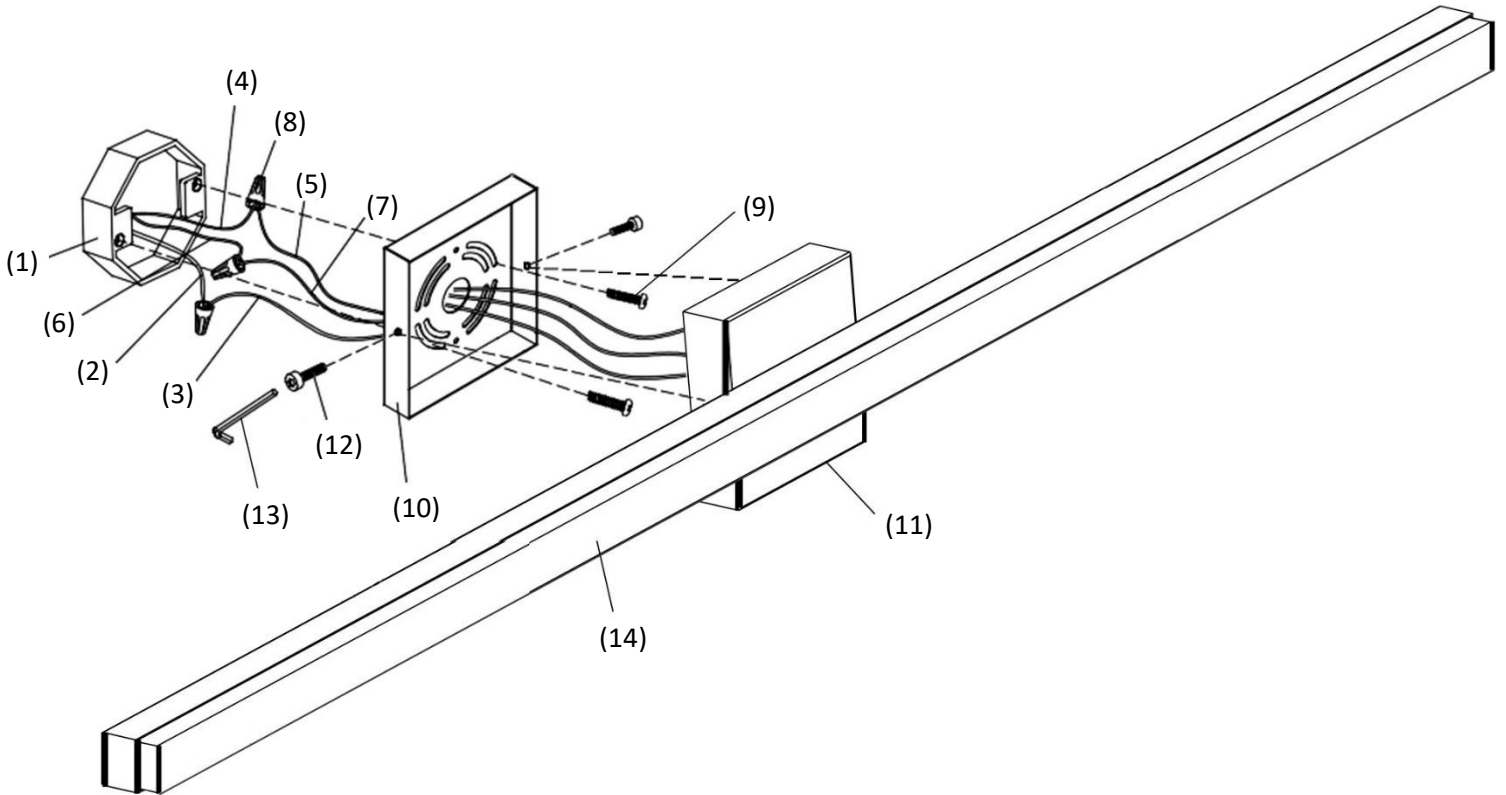

1. OUTLET BOX (by others)
2. WHITE SUPPLY WIRE
3. WHITE FIXTURE WIRE
4. BLACK SUPPLY WIRE
5. BLACK FIXTURE WIRE
6. HOUSE GROUND WIRE
7. FIXTURE GROUND WIRE

8. WIRE CONNECTORS
9. MOUNTING SCREWS
10. BACK PANEL
11. FIXTURE PAN
12. SET SCREWS
13. ALLEN WRENCH
14. ACRYLIC LENS