

# Day Recessed Light

Design by R. Toso - N. Massari & Associates

## LED



**Wattage** 1x16 W, 500 mA LED, 1500 Lumens  
1x23 W, 700 mA LED, 2000 Lumens

**Color Temperature** 2700 K, 3000 K, 3500 K, 4000 K

**Driver** Dimmable electronic driver  
ELV or 0-10 V  
(consult website: leucosusa.com for a list of compatible dimmers)

**LED Housing Options** New Construction, Remodel, Insulated, Chicago Plenum

## Lo-Voltage

**Remodel** 1x50 W, lo-voltage halogen, MR-16   
**New Construction** 1x50 W, lo-voltage halogen, MR-16   
**Insulated Ceiling** 1x35 W, lo-voltage halogen, MR-16 

**Damp Location** 

**Voltage** 120 Volts  
277 Volts

**Ceiling Cutout** 3 5/8" (92 mm)

**Trim Dimensions** Width: 5 1/4" (133 mm)  
Height: 3 1/2" (89 mm)

**Housing Dimensions** Length: 21 3/8" (543 mm)  
Width: 10" - 24 1/2" (254 - 622 mm)  
Height: 7 1/16" (179 mm)

## Certifications

Housing is UL listed

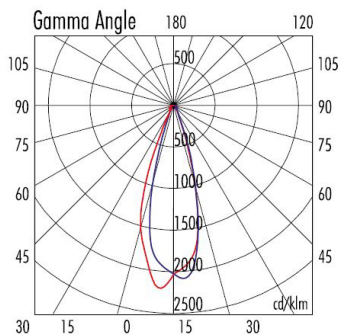

**MR16 - 50W 38°**

Lux	h	E max	E med
500	1.00	2028	1219
1000	2.00	507	305
1500	3.00	225	135
2000	4.00	127	76
2500	5.00	81	49

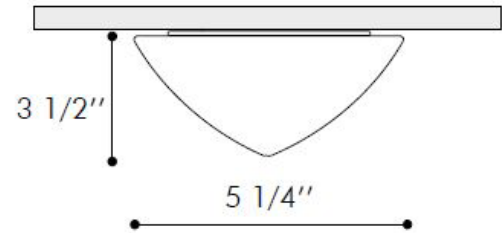

## LED Chicago Plenum Housing

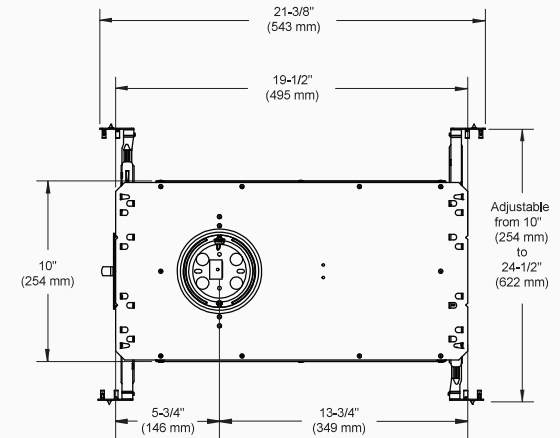
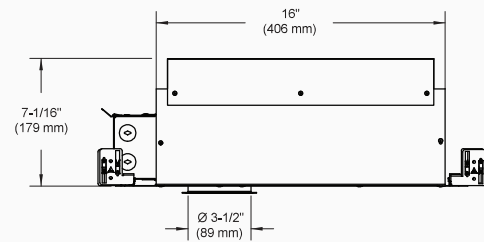

Crystal



Satin White with Crystal Tip