

Spira Recessed Light

Design by Mauro Marzollo

LED



Wattage 1x16 W, 500 mA LED, 1500 Lumens
1x23 W, 700 mA LED, 2000 Lumens

Color Temperature 2700 K, 3000 K, 3500 K, 4000 K

Driver Dimmable electronic driver
ELV or 0-10 V
(consult website: leucosusa.com for a list of compatible dimmers)

LED Housing Options New Construction, Remodel, Insulated, Chicago Plenum

Lo-Voltage

Remodel 1x50 W, lo-voltage halogen, MR-16 
New Construction 1x50 W, lo-voltage halogen, MR-16 
Insulated Ceiling 1x35 W, lo-voltage halogen, MR-16 

Damp Location Yes

Voltage 120 Volts
277 Volts

Ceiling Cutout 3 5/8" (92 mm)

Trim Dimensions Width: 5 3/8" (137 mm)
Height: 1 1/8" (29 mm)

Housing Dimensions Length: 21 3/8" (543 mm)
Width: 10" - 24 1/2" (254 - 622 mm)
Height: 7 1/16" (179 mm)

Certifications

Housing is UL listed

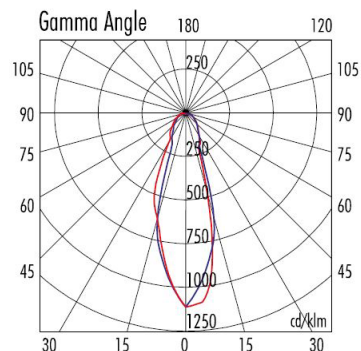

MR16 - 50W 38°

Lux			
h	E max	E med	
1.00	1028	592	
2.00	257	148	
3.00	114	66	
4.00	64	37	
5.00	41	24	

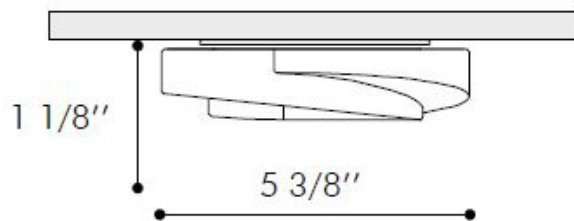

LED Insulated Housing

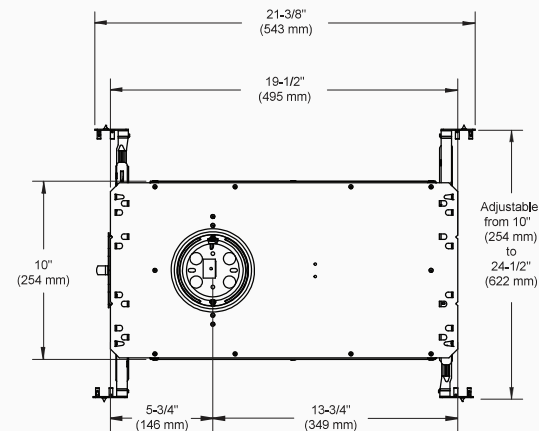
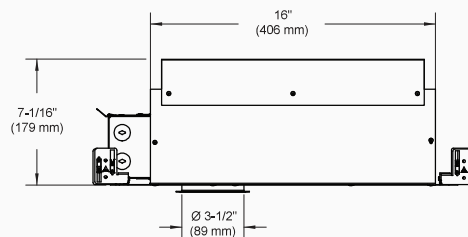

Crystal



Satin White