

# Sun Recessed Light

Design by N. Toso - N. Massari & Associates

## LED



**Wattage** 1x16 W, 500 mA LED, 1500 Lumens  
1x23 W, 700 mA LED, 2000 Lumens

**Color Temperature** 2700 K, 3000 K, 3500 K, 4000 K

**Driver** Dimmable electronic driver  
ELV or 0-10 V  
(consult website: leucosusa.com for a list of compatible dimmers)

**LED Housing Options** New Construction, Remodel, Insulated, Chicago Plenum

## Lo-Voltage

**Remodel** 1x50 W, lo-voltage halogen, MR-16   
**New Construction** 1x50 W, lo-voltage halogen, MR-16   
**Insulated Ceiling** 1x35 W, lo-voltage halogen, MR-16 

**Damp Location** Yes

**Voltage** 120 Volts  
277 Volts

**Ceiling Cutout** 3 5/8" (92 mm)

**Trim Dimensions** Width: 5 3/8" (135 mm)  
Height: 1 1/8" (29 mm)

**Housing Dimensions** Length: 15 3/8" (390 mm)  
Width: 10 - 24 1/2" (254 - 622 mm)  
Height: 5 1/2" (140 mm)

## Certifications

Housing is UL listed

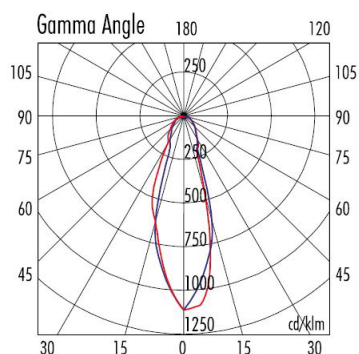

MR16 - 50W 38°

Lux			
h	E max	E med	
1.00	1028	592	
2.00	257	148	
3.00	114	66	
4.00	64	37	
5.00	41	24	

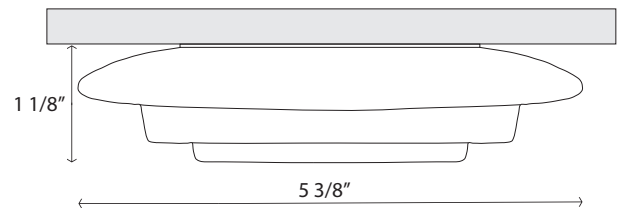

## LED New Construction Housing

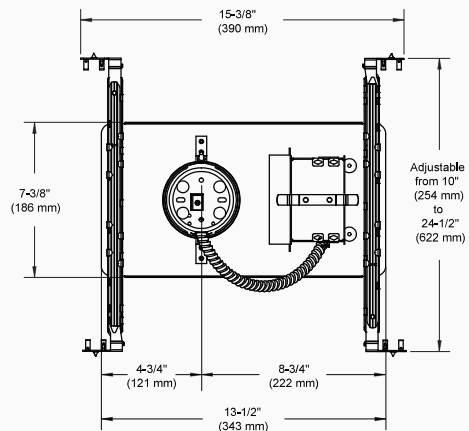
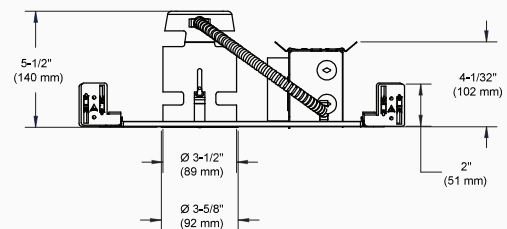

Crystal



Satin White