

WATERWORKS
STUDIO

SERVICE PARTS

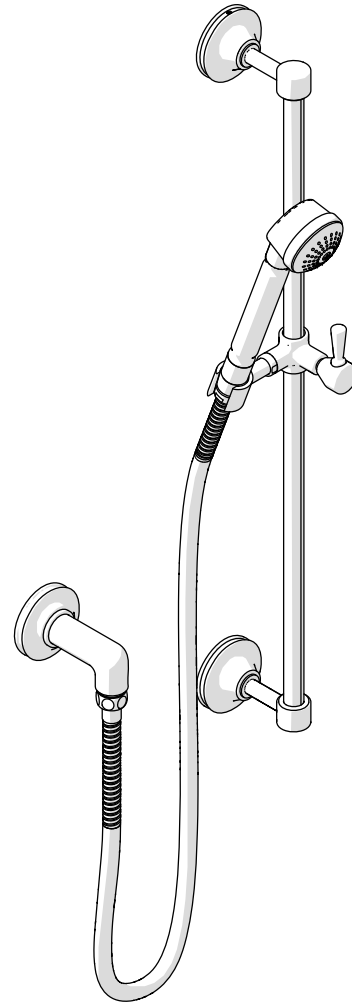

STYLE TRHS10

Transit Handshower On Bar with Metal Handle

WELCOME TO

WATERWORKS STUDIO

Over thirty years of experience distilled into signature fittings, surfaces, textiles, and accessories. Waterworks Studio is an edited collection of design solutions curated to be concise, engineered to be complete, and crafted for quality.

Everything you need, nothing more.

**TO ORDER PARTS CALL
1 (800) 927-2120 (EXT 2)**

Order by part number and specify color, finish, or other options if required.

PRODUCT SUPPORT

Our Product Support team provides troubleshooting and technical problem resolution, including replacement parts and installation recommendations throughout the life of your product.

Product Support is available Monday through Friday, 9am-6pm.

**LIMITED LIFETIME
WARRANTY**

Our warranty covers repair and replacement of Waterworks products if within the applicable coverage period and deemed defective by Waterworks. Waterworks will, at its option, repair or replace such products; this does not include installation costs, labor charges, or other incidental or consequential costs.

To obtain your complete warranty or inquire about warranty service, please visit us at www.waterworks.com or contact our Product Support Team.

MAIN KITS

776638*
SPRAY KIT

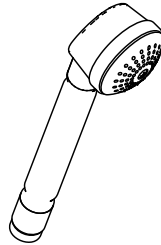

429352*
HANDSHOWER
ELBOW KIT

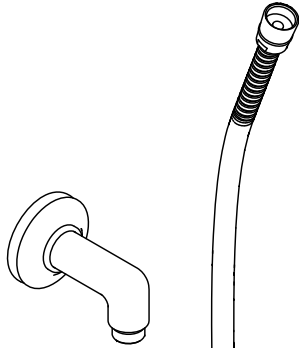

435041*
HOSE KIT

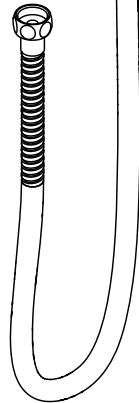

*FINISH/COLOR MUST BE SPECIFIED WHEN ORDERING
++SUPPLIED AS A PAIR

702454
HARDWARE KIT

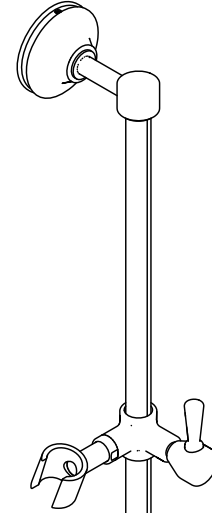
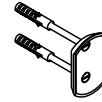

544284*
SPRAY RETURN KIT

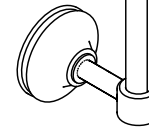
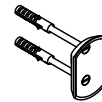

KIT COMPONENTS

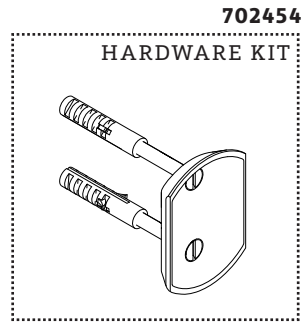

ANCHOR

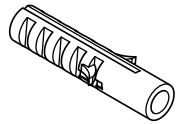
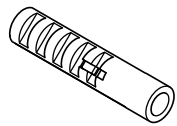

MOUNTING PLATE

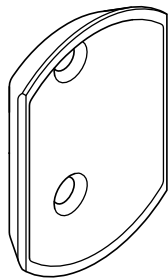

SCREW

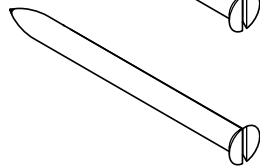
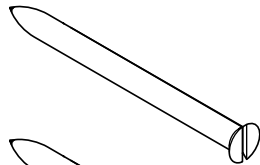

*FINISH/COLOR MUST BE SPECIFIED WHEN ORDERING
++SUPPLIED AS A PAIR

KIT COMPONENTS

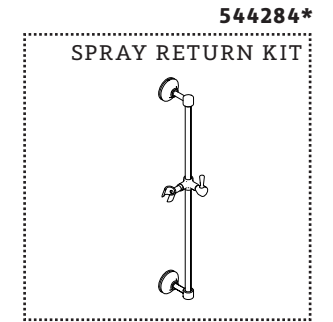

BAR END

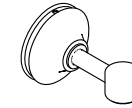

317610

FASTENING SET SCREW



094760*

HANDSHOWER
CRADLE KIT

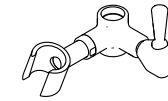

BAR



SET SCREW



BAR END

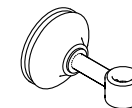

KIT COMPONENTS

094760*

HANDSHOWER
CRADLE KIT

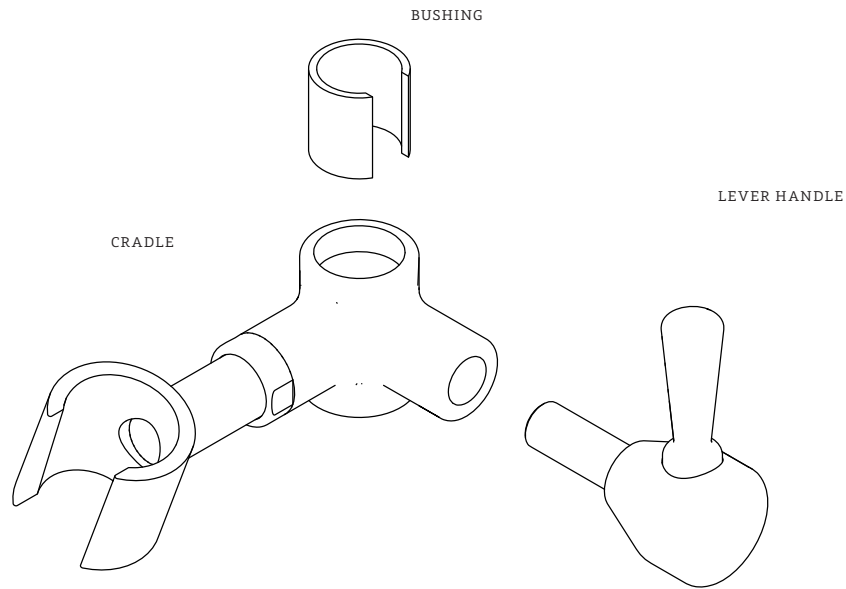
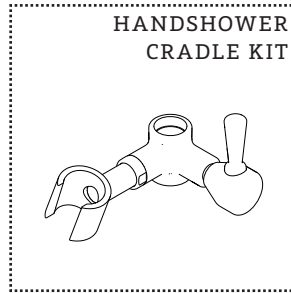

*FINISH/COLOR MUST BE SPECIFIED WHEN ORDERING
++SUPPLIED AS A PAIR

KIT COMPONENTS

429352*

HANDSHOWER
ELBOW KIT

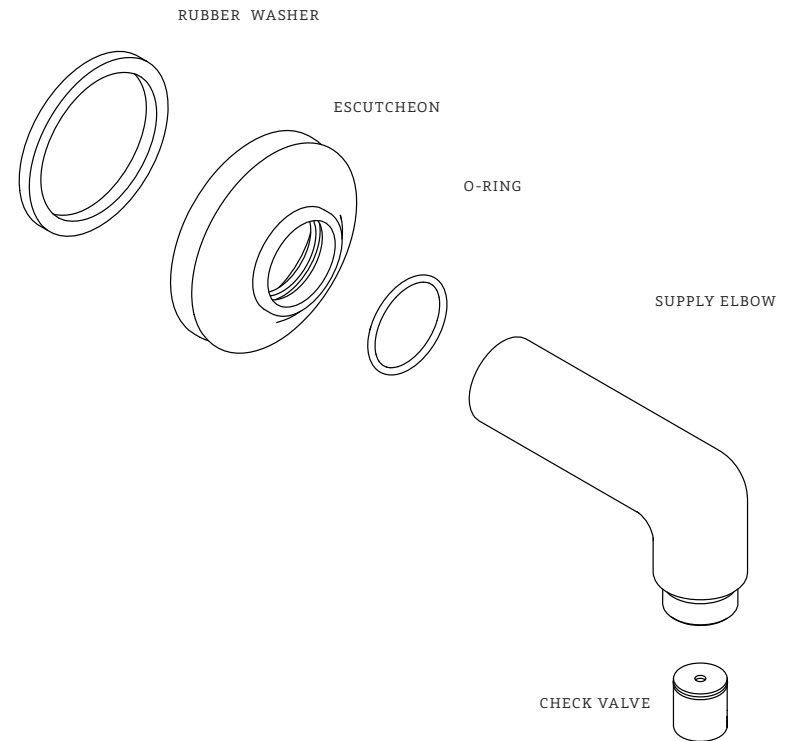

KIT COMPONENTS

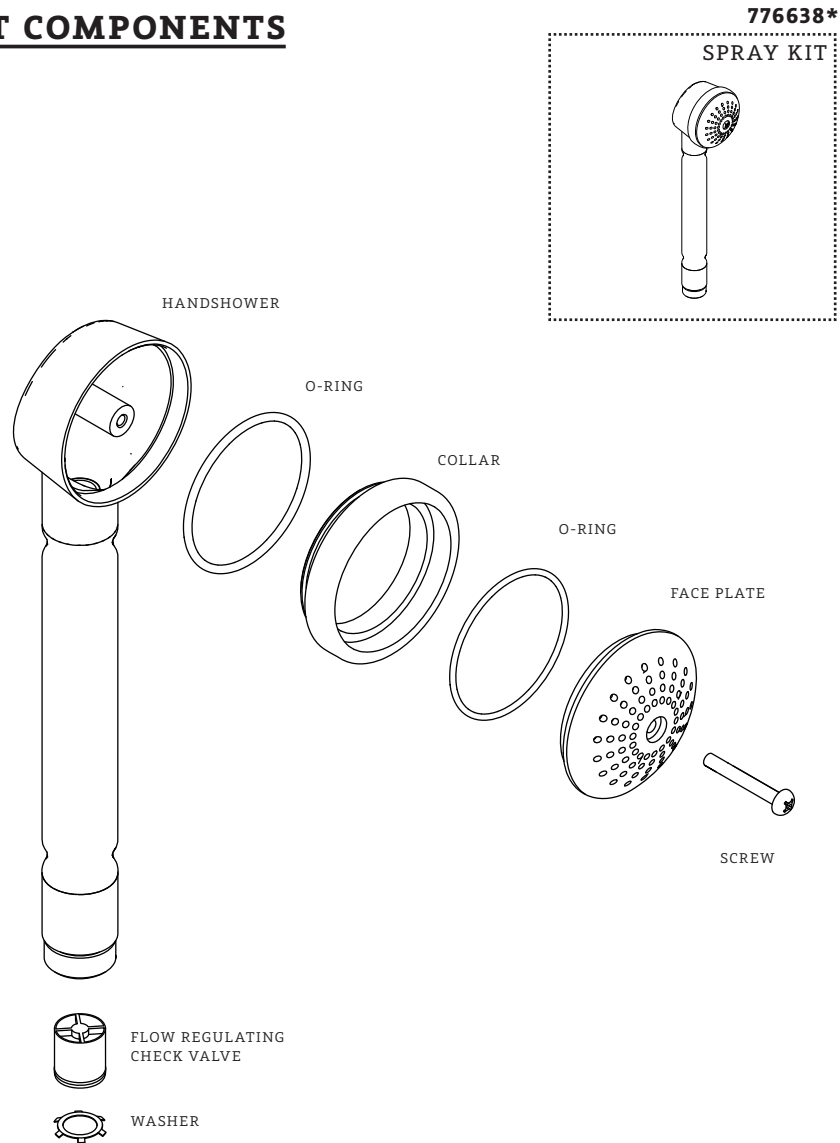

*FINISH/COLOR MUST BE SPECIFIED WHEN ORDERING
++SUPPLIED AS A PAIR

SERVICE PARTS INDEX

<u>STYLE</u>	<u>DESCRIPTION</u>	<u>PG</u>
317610	FASTENING SET SCREW	5
094760*	HANDSHOWER CRADLE KIT	5
429352*	HANDSHOWER ELBOW KIT	7
702454	HARDWARE KIT	4
435041*	HOSE KIT	2
776638*	SPRAY KIT	8
544284*	SPRAY RETURN KIT	5

WATERWORKS
STUDIO

PRODUCT SUPPORT

60 BACKUS AVENUE
DANBURY, CT 06810

1 (800) 927-2120 (EXT 2)

WWW.WATERWORKS.COM/STUDIO